The product description in this manual strives to be accurate. If there is any content error caused by technical updates or design layout, the actual product shall prevail without prior notice.



TRESANI

NEXUS SMART TOILET

User Manual

Before installing and using this product, please carefully read the product manual and keep it properly for future reference.

01/Packaging List

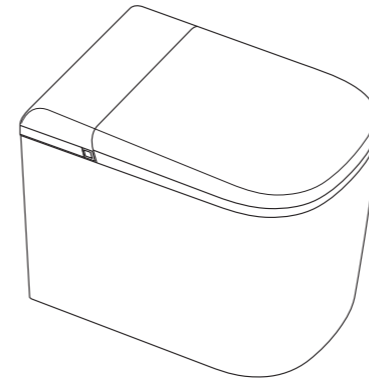

① Intelligent toilet

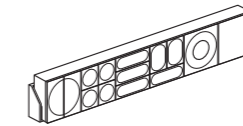

② Remote Control Assembly
(Including 1 bracket
and 2 No. 7 batteries)

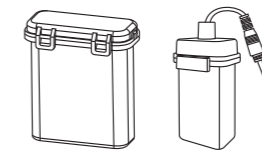

③ Backup battery box
(Large pump/pulse)

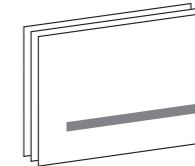

④ Instructions and other
printed materials

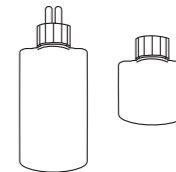

⑥ Bubble/toilet cleaner

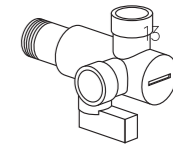

⑤ Angle valve assembly

02/Component Introduction

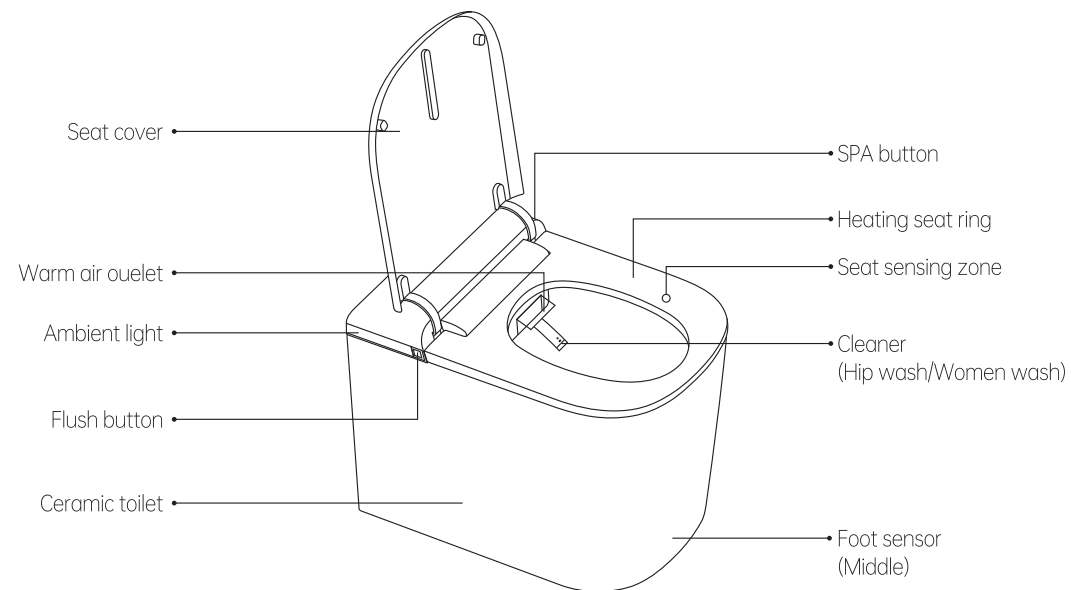

03/Product Installation

Confirmation of installation environment and specifications

1. Check whether the distance between the sewage pipes and the flatness of the bathroom meet the installation requirements.
2. Check whether the water circuit, water supply pressure, and circuit system comply with the installation requirements.
3. In addition to ensuring the required space for installation, please pay attention to whether surrounding objects (doors, cabinets, etc.) interfere with the installation and functional use of the product (seat cover, seat ring opening and closing, etc.).
4. If there is a need to renovate waterways, circuits, etc., please seek professional assistance.

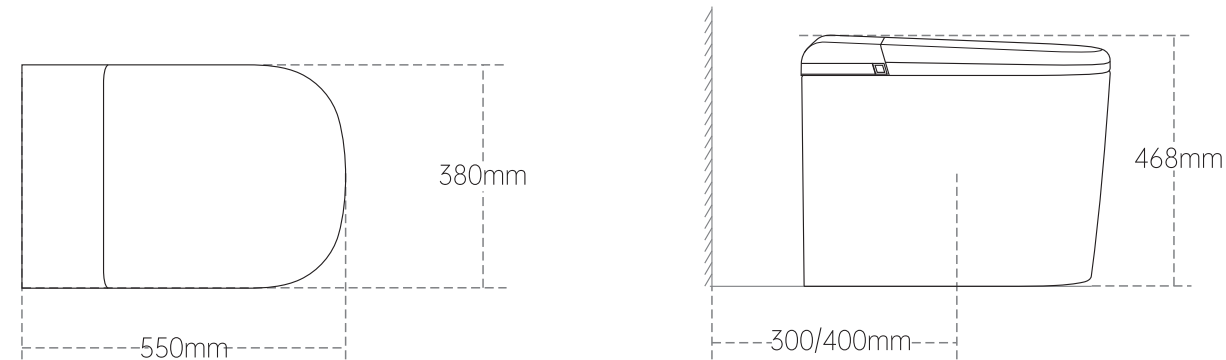

Reminder: The dimensions, accessories, user interface, etc. shown in this product are schematic diagrams for reference only. Due to product updates and upgrades, there may be slight differences between the actual product and the schematic diagram. Please prioritize the actual product.

Floor mounted toilet installation (some models)

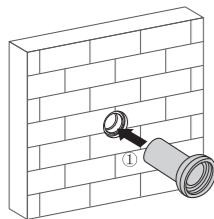

Insert the toilet drain straight pipe into the toilet drain pipe on the tiled wall as shown in Figure ①.
Note: Make sure to insert it in place!

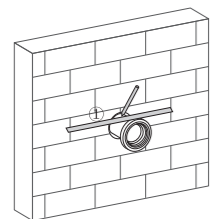

Block the toilet drain pipe with a vertical wooden board in an appropriate position and draw a line with a pencil. After the line is drawn, it needs to be pulled out, as shown in Figure ①.

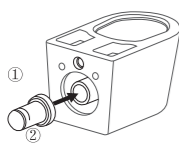

Insert the toilet drain straight pipe and rubber ring into the toilet drain outlet as shown in Figure ①.
Note: Make sure to insert it in place!

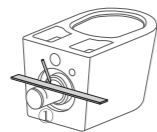

Block the toilet drain pipe with a vertical wooden board in an appropriate position and draw a line with a pencil. After the line is drawn, it needs to be pulled out, as shown in Figure ①.

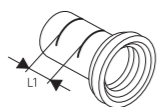

After drawing the assembly line between the toilet drain straight pipe and the toilet drain pipe and the wall mounted toilet drain outlet, mark the actual size (which is the excess part), as shown in Figure L1.

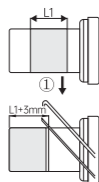

Move the excess part of the middle size of the toilet drain pipe to the edge, add 3mm before sawing it off, as shown in Figure ①.

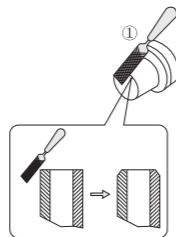

Use a file to chamfer the edge of the toilet drain pipe evenly, as shown in Figure ①.

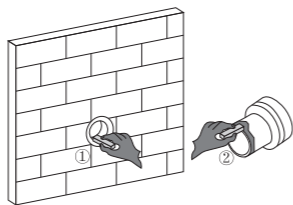

Apply appropriate silicone oil to the rubber ring of the sewage pipe as shown in Figure ① and the straight pipe of the toilet as shown in Figure ②.

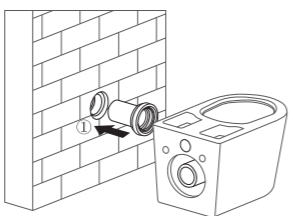

Insert the toilet drain straight pipe into the toilet drain pipe opening on the wall as shown in Figure ①.
Note: Make sure to insert it in place!

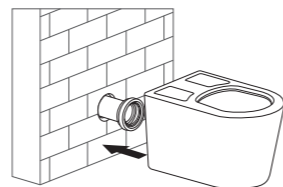

Align the toilet drain straight pipe and rubber ring with the toilet drain outlet before inserting them, ensuring that they are inserted in place.

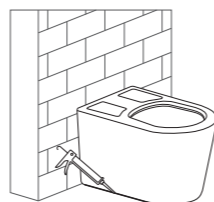

After installing the toilet, do not move it or shake it left or right, as this may damage the sealing of the toilet drain pipe and rubber ring, causing water leakage.
Apply glass glue around the bottom of the toilet to secure it.

Open the angle valve for water supply

- Connect the 4-way water inlet pipe after removing the toilet to the corner valve and tighten it for reinforcement.
- Turn the water supply supply angle valve to the left and open it to confirm that there is no water leakage at the connection. If there is any water leakage, please reinstall the component.

*Position to be determined by installer

4-way inlet pipe
Water supply angle valve

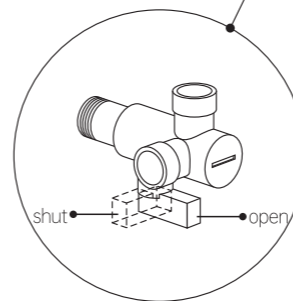

Activate the toilet

- Insert the power plug into the 220V waterproof socket; Confirm that the socket is connected to the power supply and grounded. Press the reset button to start the toilet and confirm that the plug indicator light is on.

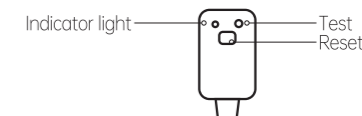

Leakage protection plug

Toilet testing machine

- After the toilet is started normally, start all functions to check whether it works normally. Start the flushing function to check whether it operates normally. Check whether the functions such as cleaning/drying can operate normally after the sensor area of the toilet seat ring is pressed tightly.
- Press the various buttons on the remote control to confirm whether it can start and stop the remote control normally.
- Press the remote control button and there is no response. Please reconnect and refer to "Remote Control Code Matching (page 11)" for the connection method

Fixed toilet

- After confirming that all functions of the toilet are working properly, fill the uneven area with filling material to prevent the toilet from shaking.
- After confirming again that there are no foreign objects or water stains on the ground, use fixing tools such as a flexible adhesive to the bottom of the toilet that comes into contact with the ground.
- Do not move or use the toilet within 48 hours after fixation.

04/Safety precautions

This product is a Class I appliance. For your life and property safety, please carefully read and follow the following precautions.

-To prevent the danger of arbitrarily resetting the fuse, this product seals the fuse; it is prohibited to use fuses that do not meet the product specifications.

-The symbols and illustrations are as follows:

Warning: Improper handling of the product may result in user death or serious injury.

Attention: Improper handling of the product may result in user injury or material harm.

Prohibited: indicates that it is not feasible or prohibited.

Compulsory: refers to mandatory compliance.



Grounding

-Confirm whether this product is reliably grounded.

-When the power supply is not grounded, it may cause faults such as leakage and electric shock.

-Please seek assistance from the electrical company or electrical operators for work grounding.



Prohibit

-Prohibition of disassembly: Non after-sales maintenance personnel or designated professional maintenance personnel of our company are prohibited from disassembling, repairing, or modifying this product.

Otherwise, it may cause fire, electric shock, and other unexpected situations.

-Do not splash water: Do not add water or detergent to or wet the product body or power plug.

Otherwise, it may cause fire, electric shock, and other unexpected situations.

-Prohibited ignition: Do not approach or put lit cigarettes or combustibles into the product.

May cause fire, electric shock, and other unexpected situations.

-Do not touch with wet hands: Do not touch or unplug the power plug with wet hands.

Otherwise, it may cause electric shock and other unexpected situations.

-Prohibit the use of faulty products, otherwise it may cause fire or electric shock, and indoor water seepage.

Please unplug the power and close the water valve to terminate the water supply in the following situations:

-When the main body or water pipe leaks

-When there are cracks or damages on the product

-When there is abnormal noise or odor

-When the product emits smoke

-When the product is abnormally hot

When the seat ring or cover plate is damaged, please stop using it to avoid dangerous situations.

Please be sure to unplug the power plug, turn off the water source, and contact the dealer or after-sales service center.

Otherwise, electric shock and fire may occur.

-It is prohibited to use water sources other than tap water or drinkable water.

Otherwise, it may cause cystitis, dermatitis, and electric shock and fire caused by internal corrosion of the machinery.

-Do not bend or flatten the connecting water pipe.

Otherwise, it may cause water leakage, reduced water pressure, or no water output.

-It is prohibited to disassemble the water pipe while the water stop valve is open.

Otherwise, it may cause splashing, spraying, or leakage.

-It is prohibited to use loose, shaking or other defective power sockets.

Otherwise, it may lead to dangerous situations such as fire or electric shock.

-It is prohibited to exceed the specified specifications of the power supply or socket, and only 220V AC power can be used.

Otherwise, it can easily cause fire and electric shock.

-It is prohibited to arbitrarily pull, damage, forcibly bend and twist, stretch, curl, bundle, bear weight, excessively pinch or damage the power plug and power cord.

Otherwise, damage to the power plug and power cord can lead to electric shock or fire.

-If the power cord is damaged, to avoid danger, maintenance and replacement must be carried out by the manufacturer, after-sales service personnel, or professional repair personnel.

Otherwise, it can easily cause fire and electric shock.

-Prohibit use in lightning weather (please unplug the power plug when lightning strikes nearby).

Otherwise, it may cause accidents or malfunctions.

-Do not pour urine into the warm air outlet.

Otherwise, there is a risk of electric shock.

-It is prohibited to put fingers or other objects into or block the heating outlet. Do not cover the heating air outlet when using the product.

Otherwise, it may cause burns, electric shock, or burning of accessories.

-Except for feces and toilet paper, it is prohibited to discard any debris inside the toilet.

Otherwise, it may cause toilet blockage, sewage discharge, or indoor water seepage.

-It is prohibited to place heavy objects on the toilet cover of the toilet, and do not hit this product. Broken products may cause personal injury, and broken toilets may cause problems such as room flooding.



Pay attention to

-Do not use the "high" or "medium" range of seat temperature, heating/air temperature for a long time.

Otherwise, prolonged use may pose a risk of burns.

-When using the cleaning and drying functions, please keep the seat in a seated state, that is, the skin is tightly pressed against the sensing area of the seat ring.

Otherwise, the product will stop cleaning or warm air drying function.

-Do not pour urine directly onto the product body or nozzle/cleaning tube.

Otherwise, dirt will be generated and cause blockage.

-Please use the new hose components that come with this machine. The old components cannot be reused. If other devices for connecting water sources are randomly equipped, please replace them together.

Otherwise, it is easy to cause water leakage and property damage.

-Please do not use in bathrooms that are too damp or easily submerged in water. Avoid spraying water on this product or rinsing it with water to prevent internal water ingress and damage.

Otherwise, it may cause electric shock and fire.

-When there is a sudden power outage, please unplug the power plug and close the corner valve to prevent water leakage.

Otherwise, it is easy to cause water leakage and property damage.

-Please avoid direct sunlight or heating equipment near this product.

Otherwise, it may cause discoloration of the product.

-To avoid danger caused by incorrect reset of the thermal circuit breaker, do not supply power through external switching devices, such as timers or connect to circuits that are timed on and off by common components.

-When not in use for a long time, please be sure to unplug the power plug, turn off the water source, and drain the accumulated water inside the product.

Otherwise, damage caused by frozen internal water accumulation can lead to fire and water leakage.

-In cold winter, when the product is transported or stored for a long time, the remaining water inside the product may freeze. To prevent damage caused by freezing, please take anti-freezing measures.

Otherwise, damage caused by frozen internal water accumulation can lead to fire and water leakage.

-In the same room or area where this product is installed, a water stop valve needs to be installed within reach, which can be used in emergency situations to cut off the water inlet of this product without the need for tools.

Otherwise, unexpected malfunctions of this product may result in user losses.

-Please do not embed cementitious materials (such as cement mortar) in the base of the toilet to prevent it from cracking due to expansion.

-Regularly unplug the power plug and wipe the dust off the power plug with a dry cloth.

Otherwise, when the insulation is poor, it can cause a fire.

-When cleaning and maintaining the toilet, do not use unsuitable cleaning agents such as concentrated sulfuric acid, concentrated nitric acid, glacial acetic acid, carbon chloride, chloroform, acetone, butanone, benzene, toluene, phenol, cresol, dimethyl formamide, methyl ether, soybean oil, acetate, 40% nitric acid, concentrated hydrochloric acid, 95% alcohol, gasoline, kerosene, brake oil, etc.

Otherwise, it may cause cracking of the plastic part, or cause personal injury, electric shock, or fire.

-Do not lean back, stand on the cover plate, or roughly open or close the seat cover or seat ring to avoid damage.

Otherwise, it is easy to cause damage and personal injury.

-Please follow the following steps when using the battery.

Only batteries that comply with national regulations are allowed to be used. Improper use of batteries may invalidate safety protection and cause



Force

-Individuals (including children) with physical, sensory, intellectual disabilities or a lack of experience and common sense should use it under the guidance of an adult.

-Children should be supervised to ensure that they do not play with this device. Otherwise, it may cause personal injury.

-Please help the following groups turn off or lower the temperature range when using the insulation seat ring/heating and drying function:

Children, elderly people, and others who cannot adjust their own temperature appropriately;

A group of people whose bodies are not free and unable to react autonomously;

People who may fall asleep after taking sleeping pills, getting drunk, or experiencing excessive fatigue.

-When installing/replacing the filter screen and filter, it is necessary to tighten them and close the water supply pipeline and angle valve.

Otherwise, it can easily cause water leakage.

-When the product leaks, please close the water valve to stop the water supply.

-It is prohibited to use this product in environments below 0 °C.

Otherwise, freezing may cause damage to the water pipe or main body, resulting in leakage or malfunction.

Maintenance and cleaning



Pay attention to

This product is an electronic product, please be careful to prevent water from entering the interior of the product. Keep the sensing area of the seat ring clean and avoid objects such as seat rings wrapping around the sensing area of the seat ring.

Dirt or foreign objects sticking tightly to the sensing area may cause product operation errors or non operation.

Do not use cleaning agents to clean the filter screen, please clean it with clean water.

-Plastic appearance

Most of the exterior components of the toilet are made of plastic. To prevent plastic damage and scratches, please clean and maintain them as follows:

Usually, wipe with a soft cloth dipped in water.

If necessary, please wipe with a cloth dipped in some neutral kitchen cleaner before wiping with water.

After cleaning the ceramic part, wipe the remaining detergent on the plastic of the toilet with a soft cloth.

As it is an electrical product, to prevent water ingress, be sure to dry it with a soft cloth after cleaning.

-Clean the angle valve filter screen (recommended to be cleaned every 3 months)

① Close the toilet corner valve and stop the water supply.

② Use a coin or a flat screwdriver to insert into the slot of the front cover of the angle valve, and rotate counterclockwise to remove the water inlet filter screen.

③ After removing the filter screen, rinse off the attached dirt with water. Generally, small attachments can be removed with a toothbrush or other tools, while larger ones can be removed with a cotton swab or other tools.

④ Turn the filter back to the angle valve clockwise, please make sure to tighten it, otherwise it may cause water leakage.

-Clean the toilet washer

① In the off seat state, press the "self-cleaning" button on the remote control to extend the washer nozzle and start draining.

② Use a soft bristle brush or toothbrush to clean the surface of the washer and remove any dirt/scale from the nozzle.

(Self-cleaning mode will automatically stop after 90 seconds of activation. You can click the "Stop" button to turn off this function in advance; do not forcefully push or pull the nozzle)

-Winter antifreeze (when the ambient temperature is below 4 °C)

When not in use for a long period of time such as business trips or outings, please empty the toilet to store water and avoid freezing and cracking.

① Close the water supply angle valve, press the flushing button on the remote control, start flushing, and empty the water tank.

② Enable self-cleaning function to drain residual water from the toilet.

③ Loosen the water supply pipe on the corner valve and pour the accumulated water in the pipe.

④ Cut off the power supply to the toilet.

(Pulse type intelligent toilets require the water supply to be turned off near the end of flushing after starting flushing to drain.)

After storing the product in a low-temperature environment for a long time, if it is moved to a room with a higher temperature, the product should be left for 30 minutes until it naturally thaws before being connected to water and electricity to avoid internal failures of the appliance. If freezing occurs, making it impossible to flush or clean, a cloth soaked in hot water can be covered on the water supply hose of the toilet or the connection part of the water supply hose to thaw it.

(Do not pour hot water or blow hot air with high temperature onto the product body, water supply hose, and other objects).

Temperature range
(Seat/Wind temperature are only displayed when adjusting)

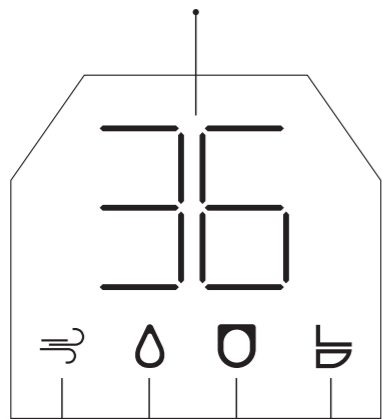

Air temp, Water temp, Seat temp tips Sitting induction

LED Screen interface

Feature & Remote Control Disclaimer

Please note that the functions outlined in this manual and remote may vary depending on the model you have purchased. Tresani smart toilets are designed with different feature sets, and some functions may apply only to selected models in the range.

To support our commitment to sustainability and reduce electronic waste, all Tresani smart toilets are supplied with a universal remote control. As a result, some remote-control buttons may not be active on your particular model.

Remote Control Pairing

After powering on the smart toilet press and hold the "SPA" on the side for 2 seconds until you hear a "beep" sound. The smart toilet is now in pairing mode, press any key on the remote control to successfully connect the device.

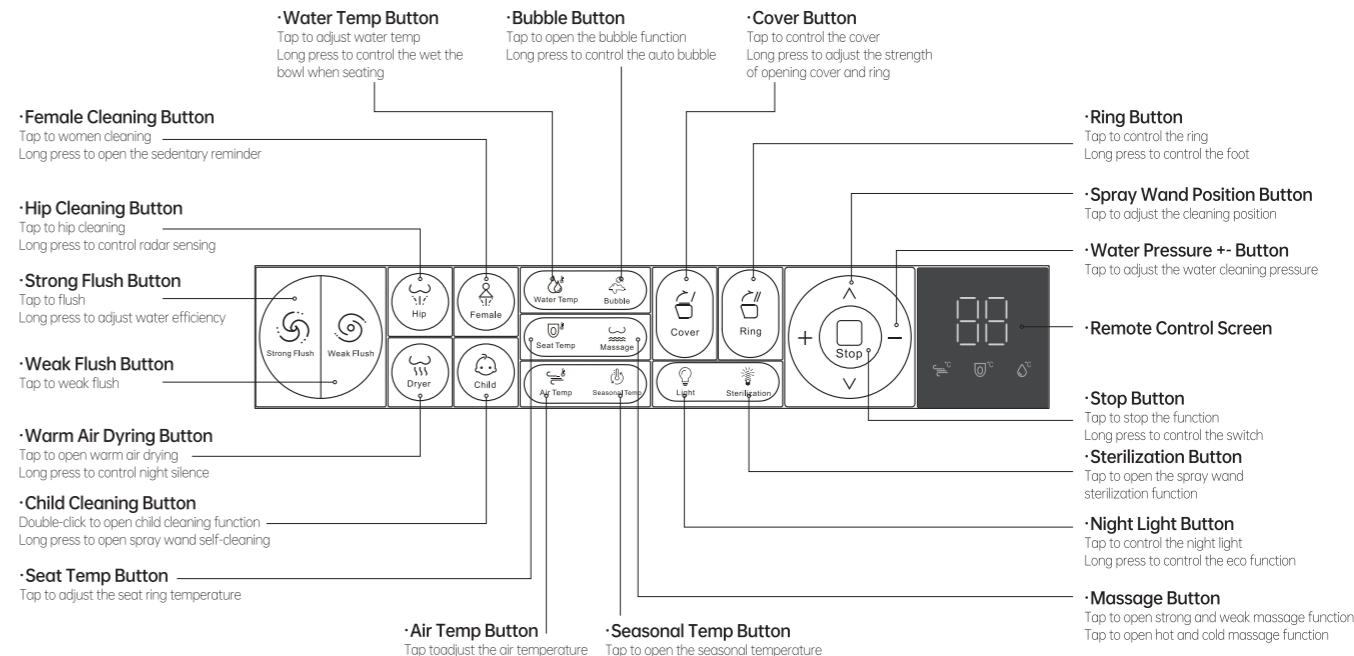

Side buttons

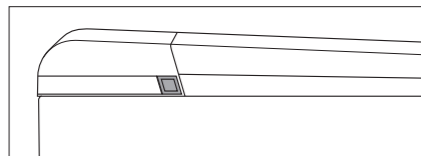

Flush Button

Tap to flush, long press to switch on/off
Long press to open warm air drying when sitting

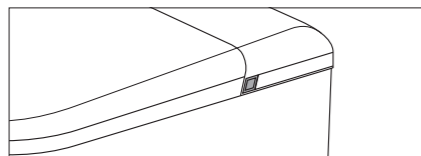

SPA Button

1. Long press for 2 seconds within 30 seconds of starting the machine. After the toilet drops, press any button on the remote control to complete the pairing.
2. After sitting, short press to start hip cleaning and cold and hot massage, automatic drying after cleaning, long press to start women cleaning and cold and hot massage, automatic drying after cleaning.

06/Technical parameters

Name (model)	Tresani Nexus	
Rated voltage	220V~	
Rated frequency	50Hz	
Rated power	1380W	
Power cord length	1.5 meters	
Flushing method	Jet siphon type	
Cleaning device	Buttock washing	The cleaning water volume is about 0.62L/min
	Women's washing	The cleaning water volume is about 0.67L/min
	Water temperature	Normal temperature - about 34 °C - about 37 °C - about 40 °C (4-speed adjustment)
	Maximum power of warm water heater	1380W
	Safety devices	Thermal cutoff, thermostat, temperature sensor
Insulation seat ring	Surface temperature	Normal temperature - about 34 °C - about 37 °C - about 40 °C (4-speed adjustment)
	Seat ring heater	45W
	Safety devices	Thermal cutoff, thermostat, temperature sensor
Dry	Warm air temperature	Normal temperature - about 34 °C - about 37 °C - about 40 °C (4-speed adjustment)
	Heating heater	270W
	Safety devices	Thermal cutoff, Bimetal thermostat
Water supply pressure	0.15MPa (dynamic pressure)-0.75MPa (static pressure) (1.5-7.5kg/cm ²) (Models with water tanks do not have this restriction)	
Waterproof grade	IPX4	
Water supply temperature	5-35 °C	
Ambient temperature	0-40 °C	
Product size	550mm * 390mm * 468mm	
Product weight	33kg	
Executive standards	GB 4706.1-2005 GB4706.53-2008 GB/T 6952-2015 GB 38448-2019	
Note: When the water pressure is lower than 0.2MPa, it is recommended that the user install a Booster pump, otherwise your normal use may be affected.		

07/Function Introduction

Classification	Function	Function Description
Basic functions	Hip cleaning	Clean buttocks function, enable this function, and the toilet will automatically perform procedures such as buttocks cleaning and drying.
	Female cleaning	The female cleaning function enables the toilet to automatically perform female cleaning, drying, and other work procedures.
	Warm air drying	Accelerate the evaporation of water droplets with warm air, making the buttocks dry and comfortable.
Comfort function	Water pressure regulation	Adjust the water pressure of the water spray during cleaning to adapt to users with different sensitivities.
	Text adjustment	Adjust the front and rear positions of the nozzle during cleaning to accommodate users with different sitting positions.
	Temperature regulation	The water temperature for cleaning, the seat temperature of the seat ring, and the air temperature for drying can be adjusted.
	Mobile cleaning	During cleaning, the water column moves back and forth for a wider range of cleaning.
	Cover Mute	Using a damping device to ensure smooth and low noise closure of the coil and cover.
Humanized functions	Comfortable night light	Soft lighting night lights, guarding the toilet at night.
	Automatic flushing	Automatic flushing is performed after the person leaves the seat.
	Foot sensation flushing	After urinating, a man flushes water by triggering a foot sensing device.
Safety functions	Anti overheating	By utilizing multiple protections such as software intelligent regulation, temperature sensors, and temperature fuses, it is possible to prevent situations such as high temperature burns.
	Anti electric shock	Install leakage protection devices to prevent the occurrence of electric shock accidents.
Cleaning function	Spray nozzle self-cleaning	Automatically clean the nozzle before and after each cleaning.
	UV sterilization spray rod	The nozzle will extend out, making it convenient for users to manually clean the nozzle. Close the cover and automatically activate the sterilization mode, using ultraviolet radiation to clean the nozzle.
Green function	The water temperature is immediately hot	During cleaning, the toilet instantly heats the cleaning water supply, saving energy and maintaining a constant temperature.
	Energy saving mode	Low power consumption mode, intelligent power saving.
High configuration features (some models)	Automatic flip	Set the human body sensor to automatically perform the flip action when approaching the sensing range.
	Automatic loop flipping	When triggering foot sensation, perform a loop turning motion, and men do not need to manually lift the seat cushion when urinating.
Built-in water tank (some models)	No water pressure restriction	Built in water tank, equipped with brushless Booster pump for pressurization, no water pressure limit, applicable to low water pressure environment.

Function	Description and adjustment method
Enthronement	The hip washing, women washing, and drying functions can only be used normally while sitting.
Thermostatic seat ring	Press the "Seat Temperature" button to cycle and adjust the seat temperature from low to high. Please choose the appropriate seat temperature for use to prevent low-temperature burns.
	When the seat temperature is in the first gear, the seat ring is not heated. When the seat temperature is in the second or higher gear, the higher the gear, the higher the seat temperature.
Clean	Rotate the knob or remote control "Hip Wash" or "Women Wash" button to clean. Each cleaning time is approximately 120 seconds.
	During the cleaning process, pressing the current cleaning mode again can turn on or off mobile cleaning;
	Press the "+" or "-" button to adjust the cleaning water pressure; Press "▲" or "▼" to adjust the cleaning position;
	Press the "Water Temperature" button to cycle and adjust the water temperature from low to high. Please choose a suitable water temperature for use to prevent low-temperature burns.
	When the water temperature is in the first gear, cleaning does not require heating. When the water temperature is in the second or higher gear, the higher the gear, the higher the water temperature.
Dry	Start the warm air drying by pressing the knob or pressing the remote control "drying" button. Each drying time is approximately 180 seconds.
	Press the "Air Temperature" button to cycle and adjust the air temperature from low to high. Please choose a suitable air temperature to prevent low-temperature burns.
	When the wind temperature is in the first gear, the wind temperature is not heated. When the wind temperature is in the second or higher gear, the higher the gear, the higher the wind temperature.
Cease	During the cleaning or drying process, press the knob or remote control "Stop" button to exit the current cleaning or drying process.
Foot induction	Foot induction activation method: Close to the infrared sensor to trigger the toilet to work.
	In the basic style, the device is activated for flushing in the off seat state.
	In high configuration styles, the device is activated for flipping, flushing, and closing.
	-In the closed state of the seat ring, trigger foot sensing to flip the cover and circle. -In the open state of the seat ring, trigger foot sensing, close the ring and cover, and initiate a flushing.
Automatic flushing	Sitting for more than 3 seconds, about 1 second after leaving the seat, the toilet will automatically start flushing once. Long press and hold the "Flush" button on the remote control for 5 seconds to turn on/off the intelligent flushing system. After turning off, the toilet stops all automatic flushing functions.
Flushing method	Flushing methods: automatic flushing, manual flushing, remote flushing, and foot feeling flushing.
	Manual flushing: Press the knob to flush once.
	Remote flushing: Press the "flushing" button on the remote control to perform a flushing.
	Automatic flushing: Refer to "Automatic flushing" above.
	Foot sensation flushing: refer to the chapter on foot sensation
	Power off flushing function: When the toilet is powered off, press the side knob to flush once.
	Attention: If the power outage and flushing are abnormal, please check the battery level or replace the backup battery in a timely manner.

Function	Description and adjustment method
Automatic flip closure	When the seat cover is in a closed state and the human body enters the sensing range of the toilet, the seat cover will automatically flip up.
	After leaving the seat, if the human body leaves the sensing range of the toilet for about 60 seconds, the seat cover will automatically close.
	Long press the remote control "flip" function to turn on or off the intelligent flip system. If the human body approaches the toilet, the seat cover will no longer be opened and will be closed. Note: This feature is only available on high configuration models.
Energy saving mode	In energy-saving mode, the toilet enters low-power mode.
	Start the energy-saving mode, set the seat temperature range to the second or higher gear, and the seat ring will automatically maintain at 25 °C. After seating, the heating will resume. Long press the remote control "energy-saving" button to turn on or off the energy-saving function.
Lighting function	The body is equipped with a low light level lamp, making it convenient to use the toilet at night.
	Press the "Lighting" button on the remote control to turn on or off the lighting function.
Standby	Press and hold the "Stop" button on the remote control for 3 seconds, and the toilet will enter standby mode. All functions will stop working.
	Press and hold the "Stop" button on the remote control again for 3 seconds, and the toilet will return to its normal working state.

08/Abnormal Function Diagnosis

When there are abnormalities in the product, please try the following handling methods to troubleshoot and solve the problem. If the problem still cannot be solved, please contact the sales unit or after-sales service center.

Product Features	Phenomenon	Inspection items	Exclusion method
Machine body	Not working at all	Whether to turn on the power	Turn on the power
		Is the power plug plugged in properly	Reconnect the power plug
		Is there a power outage	Check again after restoring power supply
Hip cleaning Female cleaning	No water from the nozzle	Is the seat sensing area sensing	Adjust the seating position to ensure that the seat ring sensor detects the human body
		Is the water supply angle valve open	Check the water supply of the angle valve
		Whether to stop water supply	Wait until the water supply is restored before enabling it
		Is there any foreign object blocking the nozzle	Clean foreign objects from the nozzle and unblock the nozzle
	Low cleaning water pressure	Is the water pressure level in the weak range	Reset water pressure
		Is the water inlet channel unobstructed	Clean the angle valve filter
	Halfway water outage	Does the sensor sense	Adjust the seating position to ensure that the seat ring sensor detects the human body
		Does the cleaning function automatically stop	Restart the cleaning function
		Whether to stop water supply	Recheck after restoring water supply
	Warm air drying	water temperature is low	Is the water temperature range in the lowest range
Low wind temperature		Is the wind temperature gear in the lowest gear	Press the remote control "wind temperature" button to adjust the wind temperature
		Halfway stop	Does the sensor sense
Seat ring heating	Does the drying function automatically stop		Restart the drying function
	Low seat ring temperature	Does the sensor sense	Adjust the seating position and confirm that the sensor senses human seating
Is the seat temperature range in the lowest range		Press the remote control "seat temperature" button to adjust the seat temperature	
Automatic flushing	Unable to flush clean	Is the flushing pipe bent or not	Adjusting the position of the water pipe
		Is there any foreign object blocking the sewage pipeline	Dredging toilets/sewage pipes
	Leave the seat without flushing	Whether to turn off automatic flushing	Enable automatic flushing function
Remote control	Remote control not responding	Low Battery	Replacing the battery
		Whether there is water ingress/soaking	Wipe dry/air dry before attempting

Warning: Except for professional maintenance personnel, please do not disassemble, repair, or modify the product without authorization

09/ Maintenance & Warranty Information

Product Registration

To help us provide you with quicker support, we recommend registering your Tresani product online within 30 days of delivery.

Registration is optional and **does not affect your standard warranty.**

Visit: <https://www.tresani.com/pages/warranties>

You will be asked to provide:

- Your name and contact details
- Product model and serial number
- Date and place of purchase

Registration helps us verify your purchase and provide support more efficiently.

Standard Warranty Coverage

Your Tresani smart toilet comes with a standard 2-year warranty. During the warranty period, our authorised service team will provide free repair or replacement for any manufacturing defects, after troubleshooting the issue.

If your product requires service:

1. Visit our support page at www.tresani.com/pages/support
2. Submit a support request with your purchase details
3. Our after-sales team will guide you through the troubleshooting and repair process

Warranty Exclusions

The warranty does not cover the following:

- Damage resulting from incorrect installation, failure to follow the user manual, or misuse
- Damage caused by fire, flooding, lightning, or other force-majeure events
- Damage resulting from transportation, dropping, impact, or improper handling after delivery
- Damage caused by the use of incorrect power supply (voltage or frequency)
- Damage resulting from use outside normal household bathroom conditions
- Wear and tear from normal ageing or cosmetic changes that do not affect function
- Inability to provide proof of purchase, if requested
- Any product that has been modified, altered, or repaired by an unauthorised technician

Maintenance Advice

To ensure reliable performance and a long service life:

- Clean surfaces only with mild, non-abrasive cleaners
- Avoid using corrosive chemicals or high-pressure sprays
- Inspect water and power connections periodically
- If unusual sounds, odours, or malfunctions occur, stop using the product immediately and contact our support team